

2012

СТАНКИ ДЛЯ ХОЛОДНОЙ КОВКИ серии “Декор”

Новые технологии в древнее ремесло

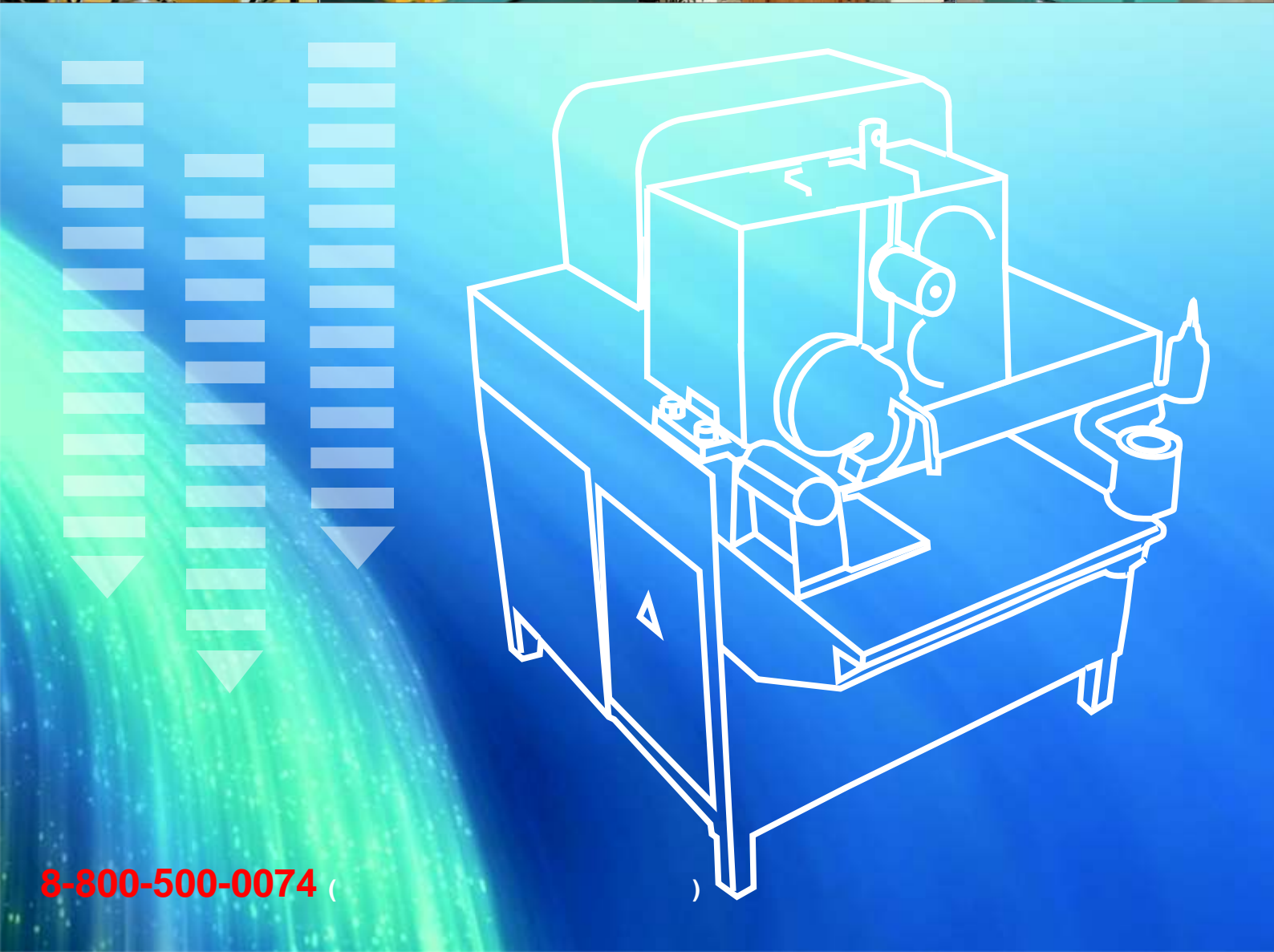

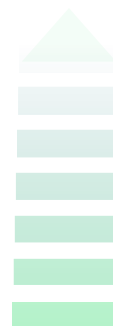

О КОМПАНИИ



2007

« » “ ” “ ” .

« ’ ” - : , , , , , .

« » . « » () , - , .

« 0,3%) , ’ , “ ; -

« » . , , , () , .

75 , « »

« , « » , « » , « » , « »

« » , « » « » !

“ ” “ , ”

















ДЕКОР



СТАНКИ "ДЕКОР"

ДЕКОР

4 " "

	(_{.4})	(² _{.13})	(_{.7})	(_{.12})	(_{.11})	(_{.11})
2	125500	168000	50000	43000	74256	75000
97000						
-						
87000			—			
- 2						
55000		—		—	—	—
1						
73000		—	—			



" -3"

30
5-7



" -4"

" "

10 159
4 .
0, 30, 45, 60

" "

1)

" - " ;

;

2)

3 :

;

3)

500 5000
;

, ,

4)

,

;

5)

:

;

6)

;

,

7)

!

УНИВЕРСАЛЬНЫЙ КУЗНЕЧНО-ГИБОЧНЫЙ БЛОК



8 20 , 2 10 10 60 ,
60 60 3 .

“ ”.

125500

-2 , - .

☐ max 60 60 3

☐ max 20 20

○ max 20

— max 60 10

∅ max 57

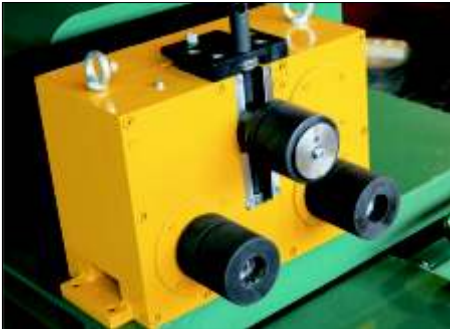

ДЕКОР

- 1) -1 -
 - 2) 57 -
 - 3) 42/21 -
 - 4) 33/26 -
- 1 -

d=57 ;
d=42, 21 ;
d=33, 26 .

57 - 7850 , 42/21 - 6800 , 33/26 - 6850 .

“ ”.
(1-3),

1-3 - 12300 ,

1-3/1 - 14000 .

☐ max16x16мм ○ max 16 мм

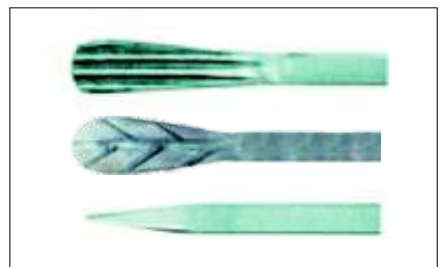

УНИВЕРСАЛЬНЫЙ КУЗНЕЧНО-ГИБОЧНЫЙ БЛОК

” -1.

“ -1 ” “ -3 ” “ -2 ” “ -6 ” “ -4 ”

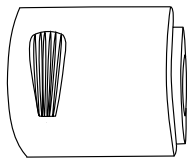

9030

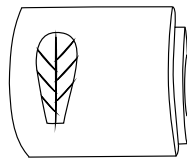

9030

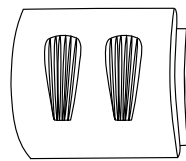

12000

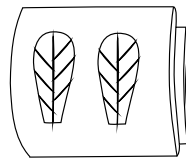

12000

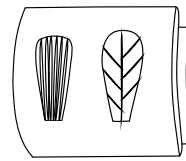

16000

3750 / .

d=50 (1-6), d=70 (1-7), d=90 (1-8), d=114 (1-9)



□ max 12x12 мм ○ max 12 мм

“ ” (1-10) 18 500 .

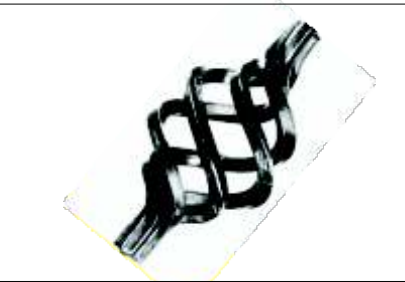

Корзинка изготавливается из четырёх сваренных у основания прутков сечением 6, 8, 10 мм.

“ ” 20 200 .

(1-11)



□ max 20x20 мм

“ ” “ ” 2 200 .

(1-12)

УНИВЕРСАЛЬНЫЙ КУЗНЕЧНО-ГИБОЧНЫЙ БЛОК

ДЕКОР

« » :
 « », « », « » . 16 , 15 15 , max 4 40 .

« - »
 (120 115)



« - 1"»
 (167 181)



« - 1"» (67 54)



« - 2"» (80 40)



« - 1"» (108 117)
 12 12



« - 12-1"» (80 40)

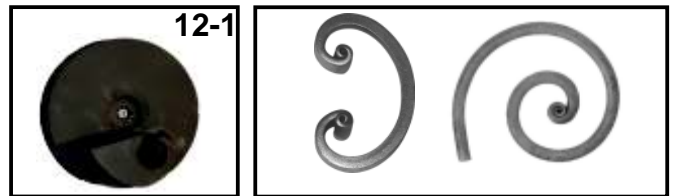

« -1"» (120 115)



2 :

1) « (1 , 1, 2, 1) ;

2) « -1" .



«	-	» (1)	(120 115)	10 000
«	-	1" (1)	(67 54)	10 000
«	-	2" (2)	(80 40)	10 000
«	-	1" (1)	(167 181)	14 500
«	-	1" (1)	(108 117)	10 000
«	-	12-1" (12-1)	(80 40)	10 000
«	-	-1" (-1)	(120 115)	15 370



МАЛЫЙ КУЗНЕЧНЫЙ БЛОК ()

“ ” “ ”

50 000

-2 , - , -1.



- 136750

-1

:

- -1 (1)

- ()
- d=114 (1-9)
- “ - ” (1)



“ ”
(1-3),

1-3 - 12300

1-3/1 - 14000

(1-3/1).

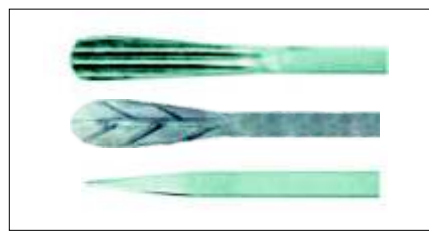

” -1.

“ -1 ” “ -3 ” “ -2 ” “ -6 ” “ -4 ”

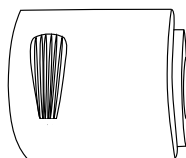

9030



9030

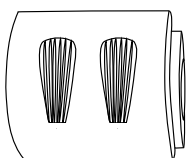

12000

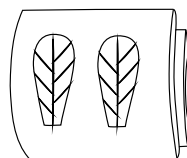

12000

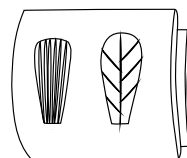

16000

МАЛЫЙ КУЗНЕЧНЫЙ БЛОК



(1)

4 20 .

- 13 000 . () .



()

- 4 30 .

- 14150 .



(2, 3)

15 15, 20 20 . (2, 3),
“ ” “ ” “ ” “ ”



2 - 6300 ., 3 - 6300 .



« » :
 « », « », « » .
 16 , 15 15 , max 4 40 .

“ - ”
 (120 115)



“ - 1”
 (167 181)



“ - 1” (67 54)



“ - 2” (80 40)

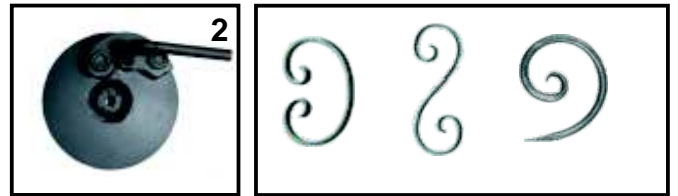

“ - 1” (108 117)
 (12 12)



“ - 12-1” (80 40)

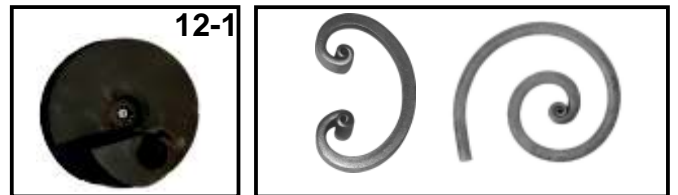

“ -1” (120 115)

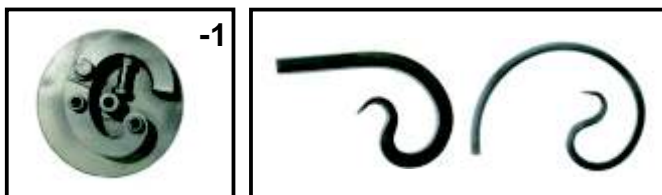

1)
 “ ” (1 , 1, 2, 1)
 ;
 2)
 “ -1”



“	-	” (1)	(120 115)	10 000
“	-	1” (1)	(67 54)	10 000
“	-	2” (2)	(80 40)	10 000
“	-	1” (1)	(167 181)	14 500
“	-	1” (1)	(108 117)	10 000
“	-	12-1” (12-1)	(80 40)	10 000
“	-	-1” (-1)	(120 115)	15 370

МАЛЫЙ КУЗНЕЧНЫЙ БЛОК

3750 / .

d=50 (1-6), d=70 (1-7), d=90 (1-8), d=114 (1-9)



“ ” (1-4)

7500 .



□ max 20x20 мм

ДЕКОР

(1-5)

“ ”

15500 .

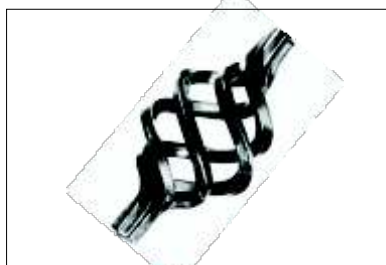

Корзинка изготавливается из четырёх сваренных у основания прутков сечением 6, 8, 10 мм.





()
 “ ”, “ ”, “ ”
 8 16 , 2 10 4 40 ,
 15 15,20 20 ().
 500) (
74256 .
 -2 , - , -1.



“ ” : “ ”, “ ”, “ ” . 16
 , 15 15 , 10 40 .
 1) “ - (1) (120 115) **10 000** .
 2) “ - 1” (1) (67 54) **10 000** .
 3) “ - 2” (2) (80 40) **10 000** .
 4) “ - 1” (1) (167 181) **14 500** .
 5) “ - 1” (1) (108 117) **10 000** .
 6) “ 12-1” (12-1) (80 40) **10 000** .
 7) « - -420” (-420) (470 440) **21 300** .
 8) “ -1” (-1) (120 115) **15 370** .

ДЕРКОР



()
 16
75000 .
 -2 , -





- ()



43000

“ ” “ ” “ ” “ ” “ ” “ ” “ ”
 8 16 , 2 10 10 40 ,
 -20 4,40 4 . .
 -2 , - , -1.

“ ”
 (1-3),

1-3 - 12300

1-3/1 - 14000

(1-3/1).



” -1.

“ ” “ ” “ ”

“

“ -1 ” “ -3 ”

“ -2 ” “ -6 ”

-4 ”

-5

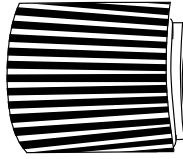
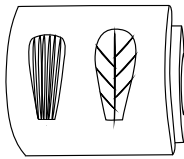
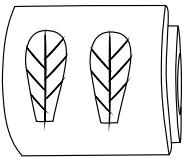
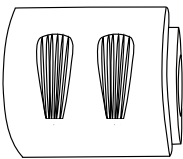
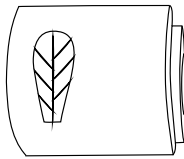
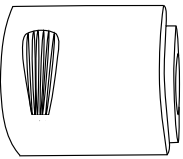

9030

9030

12000

12000

16000

12000





(2)



168000

2 , - 2.



2-0

2-0.

. 14-15).



- 26200

Офактуренный пруток

Образцы рисунков накатных роликов

Д2-0

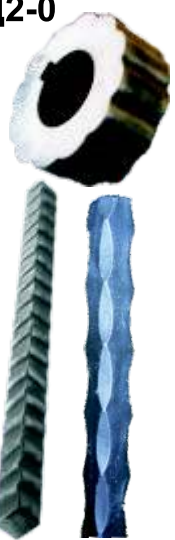

Д2-1/0



Д2-3



Д2-12



Д2-14



Схема накатного вала

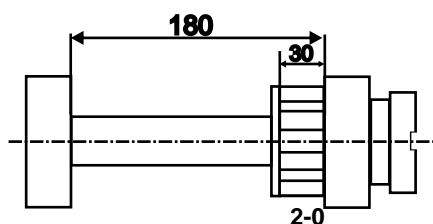

КАТАЛОГ НАКАТНЫХ РОЛИКОВ

Марка	Изображение	ширина полосы / ширина ролика, мм. Цена.
Д2-0		4450
2-0/2 (2)		8900
Д2-1/0		2500
2-1/15 (2)		10 10, 12 12, 14 14, 16 16 4 - 15 15 8900
2-1/20 (2)		20 20 8900
Д2-1		40/54 5540
Д2-2		20/30 3700
Д2-3		40/54 5540
Д2-4		40/54 4900
Д2-5		40/54 6150
Д2-6		40/54 6150
Д2-8		40/54 8900
Д2-9		40/54 5540
Д2-11		40/54 5540
Д2-12		40/54 8900
Д2-13		40/54 8900
Д2-14		40/54 8900
Д2-15		40/54 8900
Д2-16		40/54 8900
Д2-17		40/54 8900



ширина полосы
/ширина ролика мм

Д2-18		40/54 8900
Д2-19		40/54 8900
Д2-20		40/54 8900
Д2-21		40/54 8900
Д2-22		40/54 8900
Д2-23		40/54 8900
Д2-24		40/54 8900
Д2-25		40/54 8900
Д2-26		40/54 8900
Д2-27		40/54 8900
2-28		40/54 8900
2-29		40/54 8900
2-30		40/54 5540
2-31		40/54 5540
2-32		40/54 8900
2-33		40/54 8900

ширина полосы
/ширина ролика мм

2-34		40/54 8900
2-35		40/54 8900
2-36		40/54 8900
2-37		40/54 8900
Д2-38		40/54 8900
Д2-39		40/54 8900
Д2-40		40/54 8900
2-41		40/54 8900

Электроэрозионные ролики

Д2-Н1		22000
Д2-Н2		22000
Д2-Н3		22000
2- 4		18730
2- 5		22000
2- 6		22000

25, 30, 40, 50, 60 .

ДЕКОР

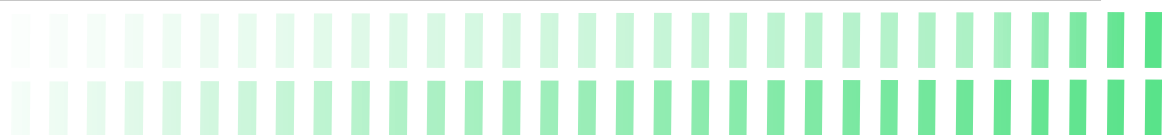



Комплект валов “Лоза” 42800

“ ”
6 20

Образец офактуренной поверхности

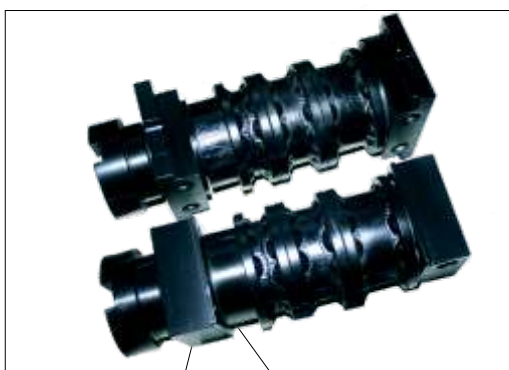

Комплект валов “Профильная труба” 42800

Предназначен для обминания профильной трубы по граням с шириной стенки 20, 30, 40 мм.

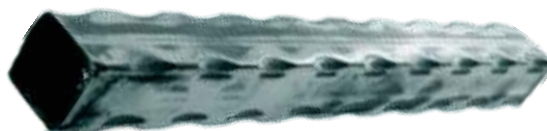

Образцы изделий



ГИДРАВЛИЧЕСКИЙ ПРЕСС "ДЕКОР-3"







(.20).

30 .
5-7 .

16 , 6 60 .

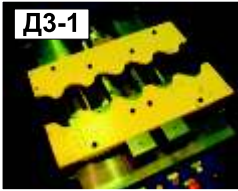
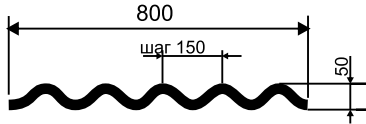
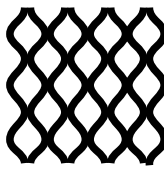
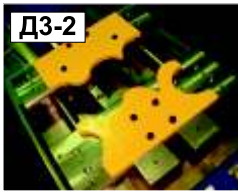
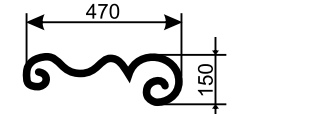
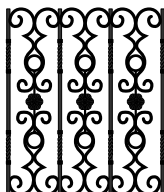
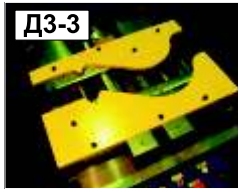
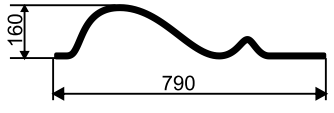
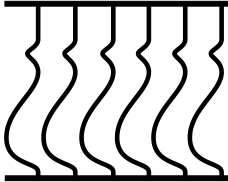
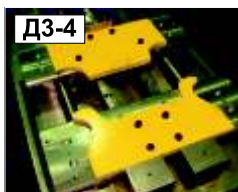
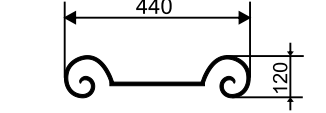

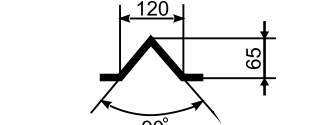
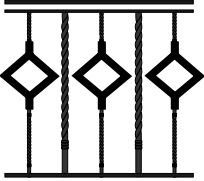

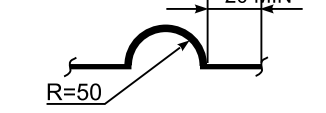
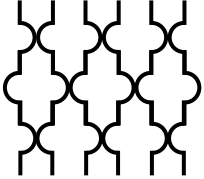



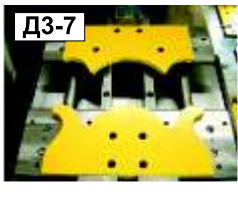
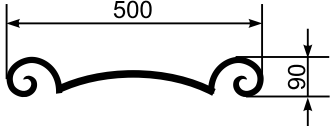
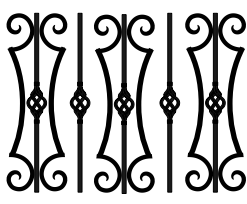

241000 .

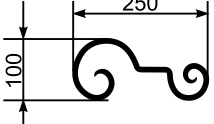
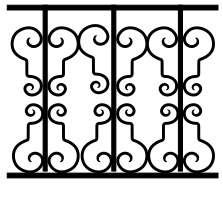
Каталог пресс-форм

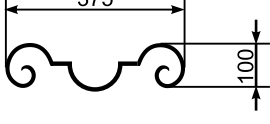
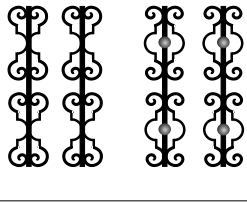
 <p>ДЗ-1</p>	 <p>□ 6-10 мм L=1000 мм ∅ 6-10 мм</p>		<p>9200 .</p>
 <p>ДЗ-2</p>	 <p>□ 8-12 мм L=650 мм ∅ 8-12 мм</p>		<p>9200 .</p>
 <p>ДЗ-3</p>	 <p>□ 6-16 мм L=930 мм ∅ 6-16 мм</p>		<p>9200 .</p>
 <p>ДЗ-4</p>	 <p>□ 10-14 мм L=650 мм ∅ 10-14 мм</p>		<p>7380 .</p>
 <p>ДЗ-5</p>	 <p>□ 8-14 мм L=250 мм ∅ 8-14 мм</p>		<p>5540 .</p>
 <p>ДЗ-6</p>	 <p>□ 8-12 мм L=210 мм ∅ 8-12 мм</p>		<p>4190 .</p>

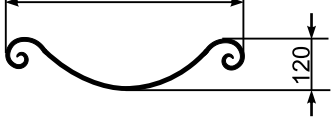
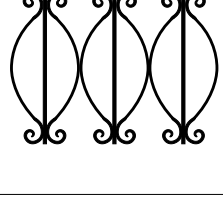
СТАНОК "ДЕКОР-3"

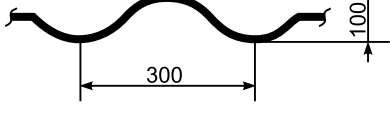
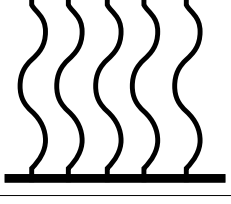
ДЕКОР

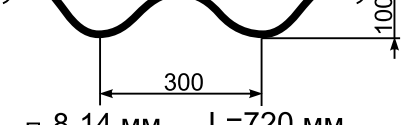
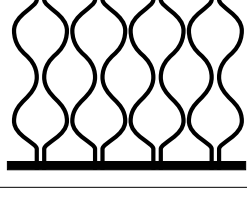
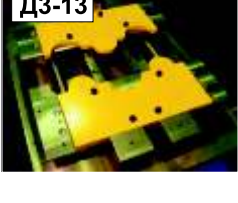
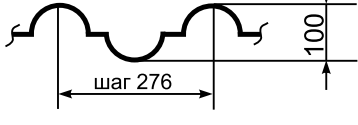
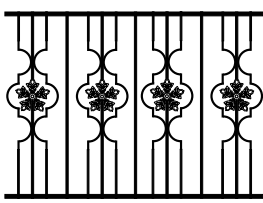
 <p>Д3-7</p>	 <p>□ 8-12 мм ∅ 8-12 мм L=750 мм</p>		<p>8620 .</p>
 <p>Д3-8</p>	 <p>□ 8-12 мм ∅ 8-12 мм L=450 мм</p>		<p>7990 .</p>
 <p>Д3-9</p>	 <p>□ 8-10 мм ∅ 8-10 мм L=700 мм</p>		<p>7990 .</p>
 <p>Д3-10</p>	 <p>□ 8-16 мм ∅ 8-16 мм L=700 мм</p>		<p>8600 .</p>
 <p>Д3-11</p>	 <p>□ 8-14 мм ∅ 8-14 мм L=850 мм</p>		<p>7990 .</p>
 <p>Д3-12</p>	 <p>□ 8-14 мм ∅ 8-14 мм L=720 мм</p>		<p>7990 .</p>
 <p>Д3-13</p>	 <p>□ 8-10 мм ∅ 8-10 мм L=720 мм</p>		<p>9200 .</p>

3-14

□ 8-14
∅ 8-14

7990 .

3-15

□ 8-16
∅ 8-16

9200 .

3-16

□ 8-16
∅ 8-16

7990 .

3-17

□ 8-10
∅ 8-10

9200 .

3-18

□ 8-14 MM
∅ 8-14 MM

5540 .

3-19

□ 6-12
∅ 6-12

9200 .

“ - ”

9200 .

СТАНОК "ДЕКОР-3"

ДЕКОР

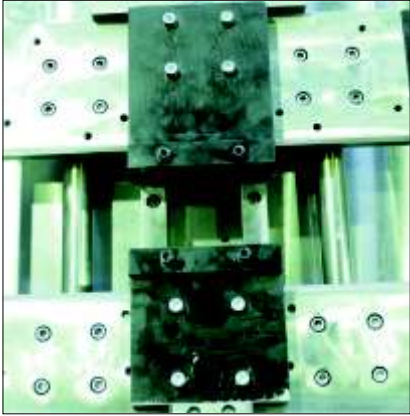

" -3" ()

" -3"

" -3"

(1-3/1).

- 37 400

- 14 000

- 12 400

*

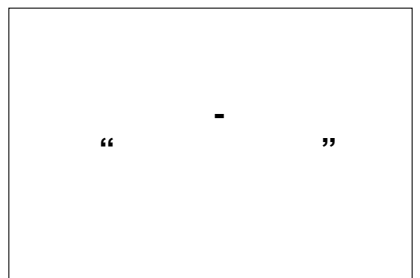
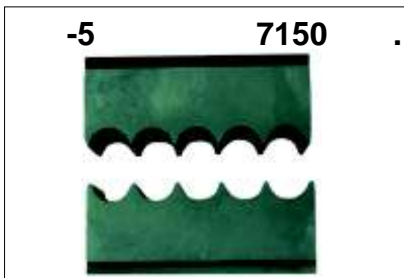
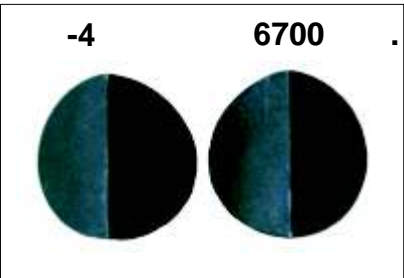
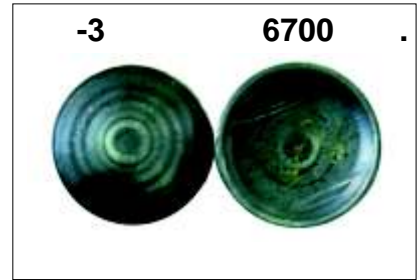
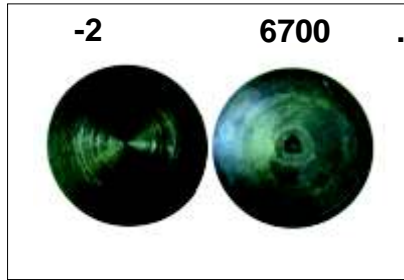
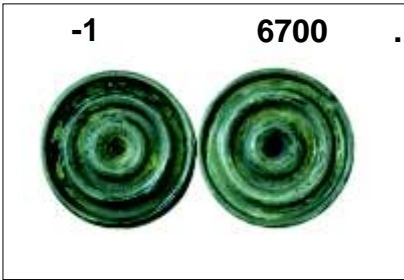

-

"

-3"

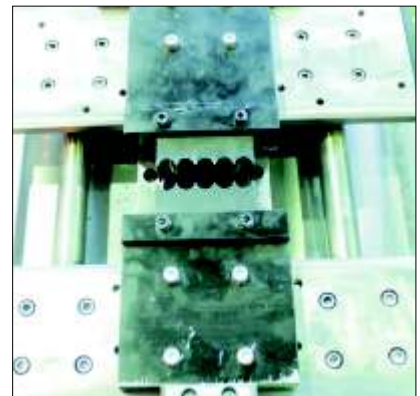
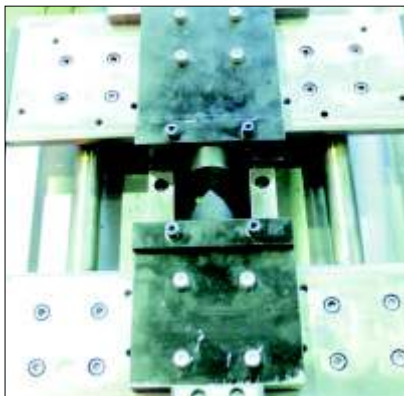
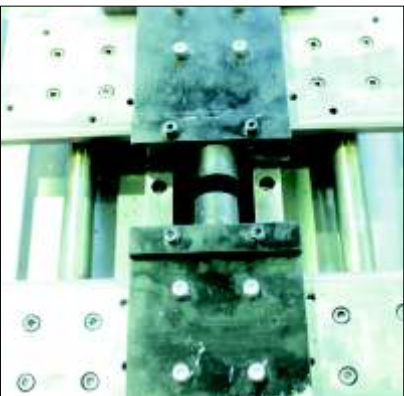

*

-

www.biokomfort.com

СТАНОК "ДЕКОР-4"



0

“ ”
 4 10 159
 : 0, 30, 45, 60
 “ ”

315000



- 10 120
 - 48 160

- 26 750

Образцы трубы с разными углами завальцовки



60°



45°



30°



0°



0

“ ”

ДЕКОР



СТАНКИ "ДЕКОР"

2 , - , - 2, 1.

		ЗНАЧЕНИЕ ПОКАЗАТЕЛЕЙ
		3,0
		380 , 50 , *
		8,5 /
		:
2		1590 955 950
-		960 816 950
- 2		970 816 950
1		820 667 950
		:
2		289
-		207
- 2		184
1		167

* 220 V

- ()

		:
" , " "	" "	Ø 8, 10, 12, 14, 16 , 15 15
" (" ")	" "	Ø 10, 12, 14, 16, 20
" "	" "	Ø 8, 10, 12, 14, 16
" "	" "	Ø 8-20 , 60 60 3, Ø 57 , 40 10
" "	" "	4 , 6, 8, 10
		Ø 10, 12
		500 270 310
		100

()

		:
" , " "	" "	Ø 8, 10, 12, 14, 16 , 15 15
" (" ")	" "	Ø 10, 12, 14, 16, 20
" "	" "	8, 10, 12, 14, 16
" "	" "	4 , Ø 6, 8, 10
		10, 12
		200 200 390
		80

- ()

:
∅ 8, 10, 12, 14, 16
200 200 390
80

(2)

:
40 10
20 20
20
40 40 3
160 /
472 296 310
120

" -3"

,
30
350
5.5
1450 /
380 , 50
1450 700 1040
1140
160
10-15

" -4"

10 - 159
1,5 - 4
12,5 /
2,5 /
0°, 30°, 45°, 60°
∅
3,3 ()
380 , 50
1250 900 1200
840

СТАНКИ “ДЕКОР”

()

:		Ø 8, 10, 12, 14, 16	
		15 15, 20 20	
		420	
		500 600 330	
		57	

ДЕКОР

		/	
		0,05 - 0,15	
		0,15 - 0,2	
		1000	
.			
.			
-		150	
-			
.		1,0 3/	
-		15,0 3/	
		246 246 286	
		25	

()

:		Ø 8, 10, 12, 14, 16	
		750 400 242	
		83	

www.biokomfort.com

8-800-500-0074 ()

“ ”
, 454108, . , 73.
.: +7 (351) 255-58-50, 255-58-53
./ : +7 (351) 258-58-50
E-mail: info@biokomfort.com
www.biokomfort.com

8-800-500-0074